

## Improvement of the resolution of the muon tracking detector in the KASCADE experiment

R. Obenland<sup>1</sup>, T. Antoni<sup>1</sup>, W. D. Apel<sup>1</sup>, F. Badea<sup>2</sup>, K. Bekk<sup>1</sup>, A. Bercuci<sup>1</sup>, H. Blümer<sup>1,3</sup>, E. Bollmann<sup>1</sup>, H. Bozdog<sup>2</sup>, I. M. Brancus<sup>2</sup>, C. Büttner<sup>1</sup>, A. Chilingarian<sup>4</sup>, K. Daumiller<sup>3</sup>, P. Doll<sup>1</sup>, J. Engler<sup>1</sup>, F. Feßler<sup>1</sup>, H. J. Gils<sup>1</sup>, R. Glasstetter<sup>3</sup>, R. Haeusler<sup>1</sup>, A. Haungs<sup>1</sup>, D. Heck<sup>1</sup>, J.R. Hörandel<sup>3</sup>, T. Holst<sup>1</sup>, A. Iwan<sup>5,3</sup>, K-H. Kampert<sup>1,3</sup>, J. Kempa<sup>5,+</sup>, H.O. Klages<sup>1</sup>, J. Knapp<sup>3,¶</sup>, G. Maier<sup>1</sup>, D. Martello<sup>1,\*</sup>, H. J. Mathes<sup>1</sup>, H. J. Mayer<sup>1</sup>, J. Milke<sup>1</sup>, M. Müller<sup>1</sup>, J. Oehlschläger<sup>1</sup>, M. Petcu<sup>2</sup>, H. Rebel<sup>1</sup>, M. Risse<sup>1</sup>, M. Roth<sup>1</sup>, G. Schatz<sup>1</sup>, H. Schieler<sup>1</sup>, J. Scholz<sup>1</sup>, T. Thouw<sup>1</sup>, H. Ulrich<sup>3</sup>, B. Vulpescu<sup>2</sup>, J. H. Weber<sup>3</sup>, J. Wentz<sup>1</sup>, J. Wochele<sup>1</sup>, J. Zabierowski<sup>6</sup>, and S. Zagromski<sup>1</sup>

<sup>1</sup>Institut für Kernphysik, Forschungszentrum Karlsruhe, 76021 Karlsruhe, Germany

<sup>2</sup>National Institute of Physics and Nuclear Engineering, 7690 Bucharest, Romania

<sup>3</sup>Institut für Experimentelle Kernphysik, University of Karlsruhe, 76021 Karlsruhe, Germany

<sup>4</sup>Cosmic Ray Division, Yerevan Physics Institute, Yerevan 36, Armenia

<sup>5</sup>Department of Experimental Physics, University of Lodz, 90236 Lodz, Poland

<sup>6</sup>Soltan Institute for Nuclear Studies, 90950 Lodz, Poland

<sup>+</sup>now at: Warsaw University of Technology, 09-400 Plock, Poland

<sup>¶</sup>now at: University of Leeds, Leeds LS2 9JT, U.K.

<sup>\*</sup>Department of Physics, University of Lecce, 73100 Lecce, Italy

**Abstract.** A Muon Tracking Detector has been built up in an underground tunnel north of the centre of the KASCADE experiment. It measures muons and their directions in EAS by using Limited Streamer Tubes. For that purpose tracks with hits in 2 and 3 modules are considered, each hit consisting of a signal from a wire pair and from influence strips perpendicular to them. Diagonal strips are used to reduce ambiguities. In order to get a good determination of the muon production height by means of triangulation, a good separation of multiple muon tracks close to the shower core and a good angular resolution is needed. Methods of improving the angular resolution of the detector system are presented. Investigations have been conducted to separate the wire pair signals and to include drift time measurements. Simulations of the electric field in a Streamer Tube cell ( $9 \times 9 \text{ mm}^2$ ) and also the distance - drift time correlation are presented, as well as the resulting detector resolution. With respect to the KASCADE-Grande upgrade the improved resolution becomes very valuable, because of increasing muon densities at higher energies of the primary shower particles.

ment is very important as some high energetic muons originate from the very first interactions of the shower. Because of the fact, that muons are not very much scattered in the atmosphere, it is also possible to investigate the longitudinal development of an EAS. For this purpose a large muon tracking detector (MTD) was established (Doll et al., 1995; Atanasov et al., 2000) which, in combination with the shower core position determined by the KASCADE array, allows to reconstruct the muon production height by means of triangulation (Büttner et al., 2001).

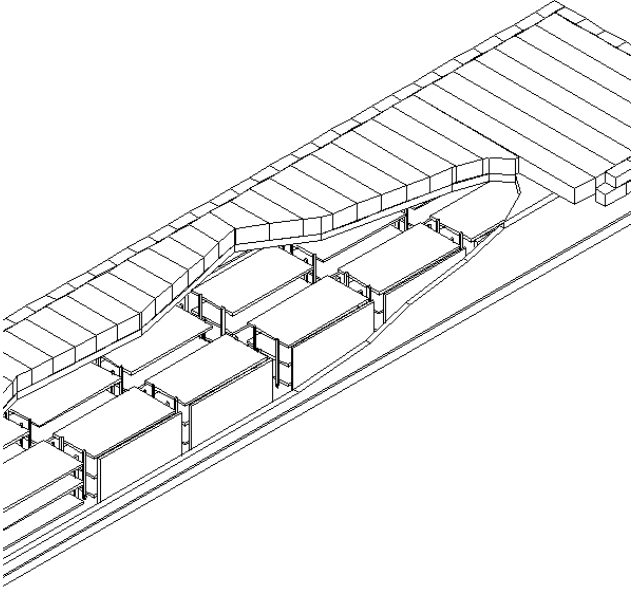
The MTD (Fig. 1) has 16 towers in two rows, each consisting out of 3 horizontal and one vertical module, and is extending in geomagnetic north-south direction. The wire signals from the 12 streamer tubes (ST) give the x-position of a muon track along the short side of the towers, while the y-position is given by influence strips, perpendicular to the wires. To resolve ambiguities in case of two or more coincident tracks additional diagonal influence strips are used. The wire cells in the streamer tubes, formed by an extruded comb profile made out of conductive PVC (Bartl, 1991), have a cross section of  $9 \times 9 \text{ mm}^2$ , and are 4000 mm long. Extensive studies have been conducted to find an appropriate cover for the open comb profile (Pentchev et al., 1997). To reduce the numbers of readout channels two wire cells are combined together on the adapter board (see Fig. 2 in Zabierowski et al. (2001)). For stable operation of the detectors the cluster sizes for the wire pairs and perpendicular influence strips amount to 1 and 2.4 respectively. For further information on the MTD read Zabierowski et al. (2001). The angular resolution of the MTD, taking into account the multi-

---

### 1 Introduction

The KASCADE experiment (Klages et al., 1997) measures the hadronic, electromagnetic and muonic component of extensive air showers (EAS) caused by cosmic ray particles in the energy region of the knee. Especially the muon compo-

*Correspondence to:* R. Obenland (obenland@ik1.fzk.de)



**Fig. 1.** Schematic view of the MTD of KASCADE. 48 m in y-direction, 5.4 m in x-direction and 2.5 m in z-direction.

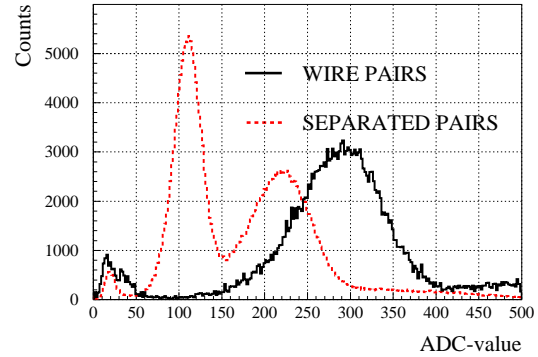
ple scattering of the particles in the air, in the detector and in the absorber, the detector geometry and its precision is also discussed there.

## 2 Methods to improve the resolution

The angular resolution of a tracking detector, determined purely by its geometry, we call the *geometrical resolution*. This resolution of the MTD can be improved in two steps. First, by the separation of the wire pair signals and, as a next step, by using the drift time of the electrons from the point of ionization of the gas molecules to the anode wire in the centre of the streamer tube cell. The investigations presented below have been performed by using tracks with hits in every of the three horizontal modul planes. The experiment was carried out by starting readout of a test tower with a plastic scintillator telescope.

### 2.1 Wire pair separation

To distinguish which of the two combined wire cells in a ST is crossed by a muon the circuitry on the adapter boards was modified. The signal of one wire was attenuated with additional resistors. So the integrated charge signal from one wire

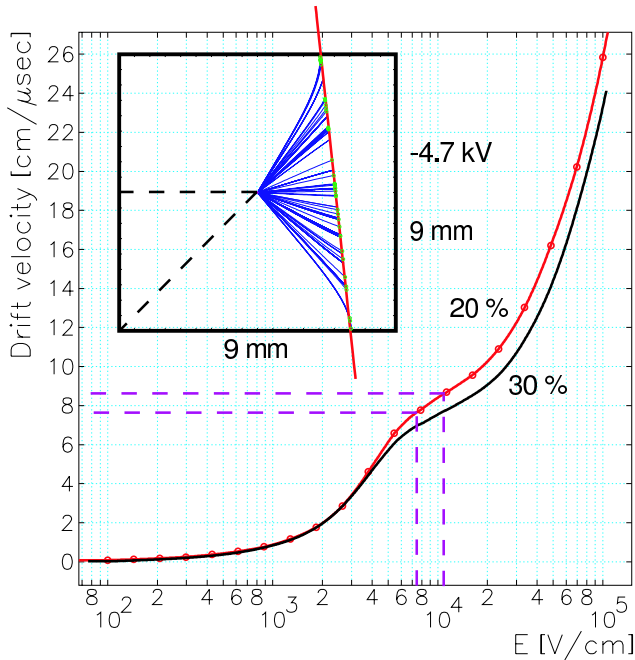


**Fig. 2.** ADC-spectra for combined (solid curve) and modified (dashed curve) wire pair coupling on the adapter boards.

becomes smaller than from the other one. Fig. 2 presents the resulting ADC-spectra which allow to distinguish the individual wire cell. In addition, a distribution of the ADC-values measured with the adapter boards in their original layout is shown. It can be seen that not only the signal of the wire cell with the modified readout is attenuated, but also the signal from the other wire cell. Although the forms of the distributions in height and width of the two wire cells are not the same anymore, their number of entries is still the same, so no loss of events occurs, since all signals remain above the threshold. Very inclined tracks can pass through two neighbouring cells and can exhibit additive adc-values. To treat the remaining overlap of the neighbouring wire cells the probability for a specific decision, for a specific wire cell, can be checked with the decisions which have been done in the other two modules for the considered track, because the single cells in the top, middle and bottom module should lie in a line as good as possible. Slightly different methods of signal separation will also be investigated in future.

### 2.2 Drift time

After the classification in the individual wire cells the drift time measurement can be used. Because of the square cross section of  $9 \times 9 \text{ mm}^2$  of the wire cells the drift velocity of the electrons in the gas depends very much on the position in the cell and the strength of the electric field there, as can be seen in Fig. 3, simulated with Garfield (7.03) program, for the used gas mixture with 20 % and 30 % of Isobutane respectively ( $-0.09 \text{ cm}/\mu\text{sec vol.}\%$ ). The shoulder in the drift velocity at around  $10^4 \text{ V/cm}$  is due to the collision cross sections of the electrons for the various gas molecules. The drift velocity decreases with increasing pressure ( $-0.01 \text{ cm}/\mu\text{sec mb}$ ), because the mean free path between subsequent collisions of an electron with the gas molecules becomes shorter, while for temperature the drift velocity increases ( $+0.02 \text{ cm}/\mu\text{sec K}$ ). With high voltage of  $-4.7 \text{ kV}$  at the cathode profile the strength of the electric field depends on the distance between wire and

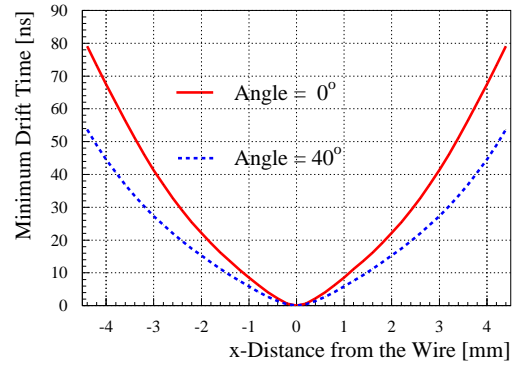


**Fig. 3.** Drift paths for about 60 primary electrons are shown and the dependence of the drift velocity of the electrons on the electric field for gas mixtures of 78:20:2 and 68:30:2 CO<sub>2</sub>:Isobutane:Ar (vol.%) at 1 atm and 300 K. The square cross section of the wire cells leads to a smaller drift velocity out of the corners of the profile, due to a weaker field in these directions.

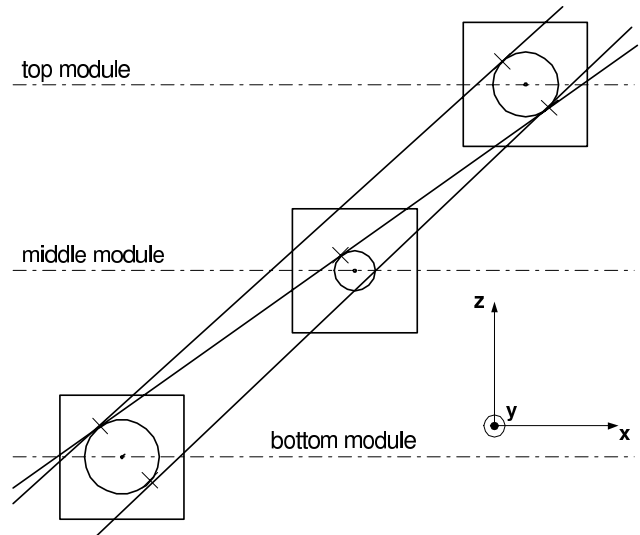
wall of the wire cell, which differs from 4.5 mm to  $4.5\sqrt{2}$  mm into the corner of the cell. Therefore, a range of the electric field from 7.4 to 10.4 kV/cm at the edge of the profile is given. The electrons follow the field lines which leads to longer drift times out of the corners. The stability of the drift velocity also depends on the stability of the used gas mixture. If the fraction of isobutane increases the drift velocity becomes slower.

The measured drift time distribution ranges from 0 to 80 ns with an accumulation of shorter drift times. The population of smaller drift times in the experiment is partly due to earlier stop signals from neighbouring cells (in the case of combined cells) or can be explained with the simulated  $x(t)$ -correlation (Garfield, 7.03) in Fig. 4. There, the dependence of the drift time (for the fastest electron out of the ionization along the muon track) on the distance between the track, where it crosses the wire plane, and the wire is shown. This parabolic shape of the curve leads to shorter drift times. For inclined tracks the minimum distance between track and wire decreases, so the drift time becomes shorter than for vertical tracks - for tracks crossing the wire plane at the same distance from the wire. Corrections due to the distance in  $x$ , between the track and the wire, and the angle of a track still have to be included in the future analysis. Detailed investigations of the zenith and azimuth angle dependence of the shortest possible electron drift times are going on.

Another effect is the ambiguity on which side of the wire a

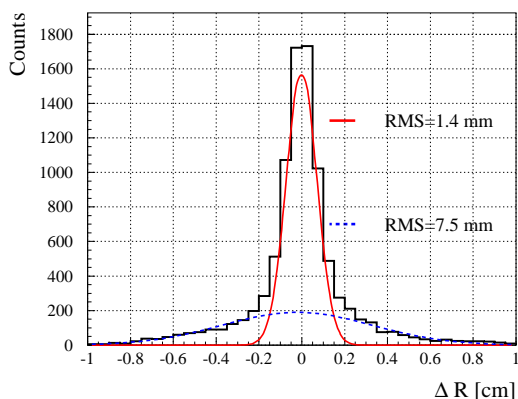


**Fig. 4.**  $x(t)$ -correlation depends from the distance between the track and the wire in the wire-plane and on the zenith angle of the track.



**Fig. 5.** The ambiguity on which side of the wire the muon crosses the cells is resolved with a least squares fit of all possible track solutions for the three modules.

track crosses the cells in each of the three module planes. The drift time measurements provide drift time circles around each wire with a precision of a few hundred micrometer, depending on the accuracy of the time measurement. An improved *constant fraction discriminator* should be employed in the future. Various possible muon tracks can be fitted to these circles (Fig. 5) in the  $x$ - $z$  plane. The positions where the track tangents to the circles and the angle of the track can be derived from the  $x$ - and  $z$ -positions and the radii of the drift time circles of two modules, as described by Oh et al. (1991). Then, the obtained track solutions can be projected onto the third module and compared with the measured drift radius there. To resolve the ambiguity on which side of the wire a track has crossed the cell, the solution with the minimum mean square deviation out of a least square fit for all possible



**Fig. 6.** The distance distribution between measured and projected positions in the middle module can be fitted by two Gaussians.

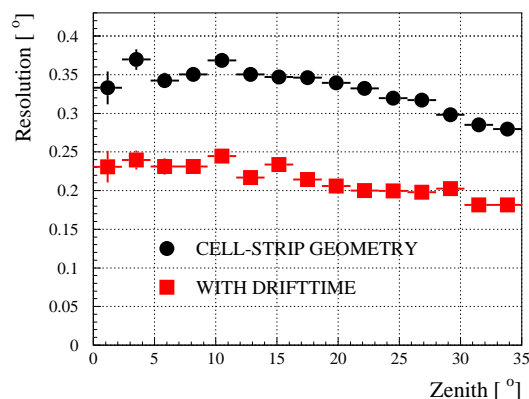
tracks is employed. However not in all cases the fit results in a unique solution. For the future operation of the MTD one can consider to install additional ST modules shifted by half a cell width to the side with respect to the already installed modules to reduce this left-right ambiguity around the wires.

Fig. 6 presents a difference distribution which gives the deviation of the tracks, derived from the  $x$ - and  $z$ -positions and the drift times of the top and bottom module, from the measured positions in the middle module. The difference distribution is fitted by two Gaussians. The less correlated events can be attributed to limited ADC separation (see Fig. 2). The remaining RMS of 1.4 mm will be further improved by taking into account the fully parametrized - zenith and azimuth dependent -  $x(t)$ -correlation, either derived from simulation (Garfield) or from additional measurements, being considered for future upgrades.

### 3 Improved resolution

To investigate the influence of the improved track resolution on the geometric angular resolution (Zabierowski et al., 2001) a MC calculation was performed. This simulation starts with a muon track distribution in zenith and azimuth angles as observed in real showers. These tracks are propagated through the 3 detector modules where wire and strip hits are registered. Based on wire-strip cluster sizes of  $1 \times 1$  that define a hit area of  $20 \times 20 \text{ mm}^2$  the difference angle between the incoming track and the reconstructed track is accumulated in a histogram. The solid points in Fig 7 give the mean value of this difference distribution as a function of the zenith angle. The slight improvement of the mean value for large zenith angles can be explained with the decreasing effective distances between two wires or strips and larger effective distances between the measured  $x$  and  $y$  module coordinates, for inclined muon tracks.

Taking into account the result, that from the measurement



**Fig. 7.** Simulated geometrical resolution for using wire pairs and including drift time measurement for all azimuth angles.

of the electron drift times in the wire cells an improved location of the muon track along the  $x$ -coordinate can be obtained, a similar MC simulation, based on a  $1.4 \times 20 \text{ mm}^2$  grid structure, leads to the mean values given by the squares. An improvement of about 40 % in the geometric angular resolution is observed.

For the future operation of the MTD in the environment of KASCADE-Grande (Bertaina et al., 2001) a MTD with improved resolution would be very helpful for tasks, like investigation of muon production heights close to the shower core or improved determination of muon densities and muon multiplicities.

*Acknowledgements.* The KASCADE experiment is supported by Forschungszentrum Karlsruhe and by collaborative WtZ projects in the frame of the scientific-technical cooperation between Germany and Romania (RUM 97/014, Poland (POL 99/005) and Armenia (ARM 98/002). The Polish group (Soltan Institute and University of Lodz) acknowledges the support by the Polish State Committee for Scientific Research (grant No. 5 P03B 133 20).

### References

- Atanasov, I. et al., KASCADE, FZKA 6474, Forschungszentrum Karlsruhe.
- Bartl, W., Nucl. Instr. and Meth. A305 (1991) 82.
- Bertaina, M. et al., (KASCADE Collaboration), Proceedings of 27th ICRC, Hamburg (Germany) 2001, HE 1.8.26.
- Büttner, C. et al., (KASCADE Collaboration), Proceedings of 27th ICRC, Hamburg (Germany) 2001, HE 1.2.30.
- Doll, P. et al., Nucl.Instr. and Meth. A367 (1995) 120.
- Garfield Version 7.03, CERN Software from Rob Veenhof, Reference W5050, <http://consult.cern.ch/writeup/garfield/>.
- Klages, H.O. et al., (KASCADE Collaboration), Nucl.Phys.B (Proc.Suppl) **52B** (1997) 92.
- Oh, S.H. et al., Nucl. Instr. and Meth. A303 (1991) 277.
- Pentchev, L. et al., Nucl.Instr. and Meth. A399 (1997) 275.
- Zabierowski, J. et al., (KASCADE Collaboration), Proceedings of 27th ICRC, Hamburg (Germany), HE 1.8.32.